

---

)

(

:

---

// : // :

E-mail: [international@ut.ac.ir](mailto:international@ut.ac.ir)

.()

---

.()

( )

:

(

/  
.()

.()

)

(

.()

(

.()

.( )

Riverside Paper Co.

.()

---

Old Newsprint(ONP)  
Mixed Office Waste(MOW)

---

( )

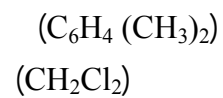

pH °C

( )

: •

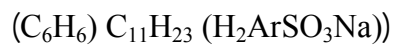

/

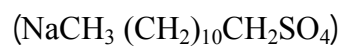

N N N N :

•

N-Cetylc (CH<sub>3</sub>)<sub>3</sub> )

)

/

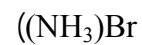

(

/ cm × / cm

/ cm × / cm

)

:

(

:

...

( ISO)

(Sunny Blender)

)

.(

GLM

SPSS SAS

( )

:

		/			
				°C	
ONP	MOW-ONP	MOW			

.( / ) pH ( / / )

\_\_\_\_\_

( ISO )

/	/	
/	/	
/	/	

( )

GLM

**	**	t	
ns	ns	T	
**	**	a	
**	**	p	
ns	ns	t×T	
*	*	t×a	
ns	ns	t×p	
ns	ns	T×a	
ns	ns	T×p	
**	**	a×p	
ns	ns	t×T×a×p	

( )

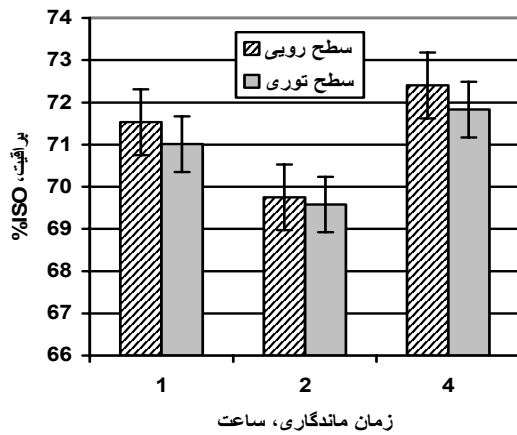

GLM

×

×

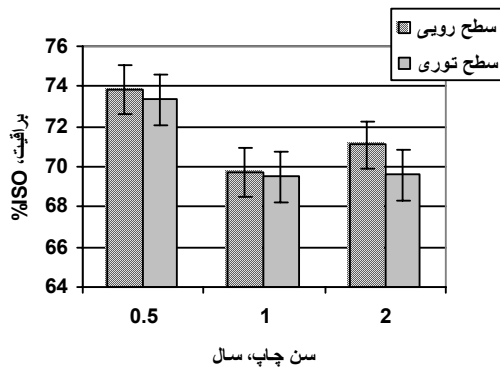

( )

( )

( )

( )

( )

( )

/ / /

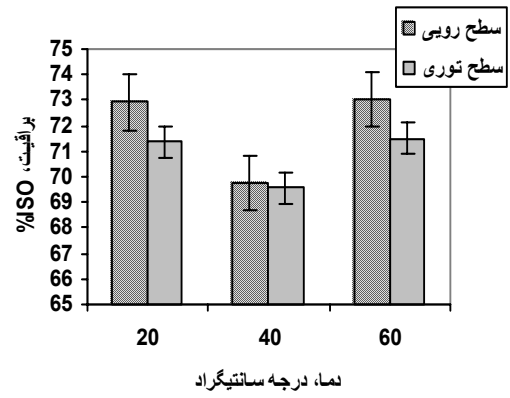

/ /

( )

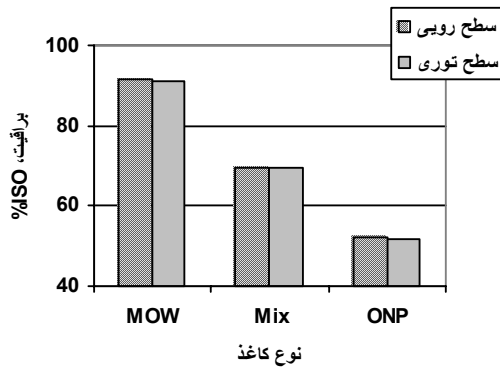

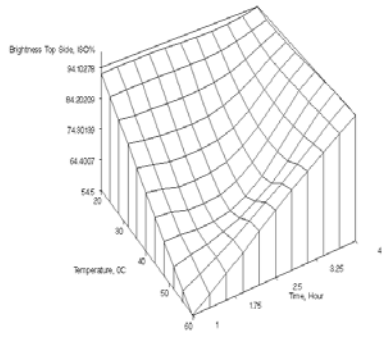

SAS

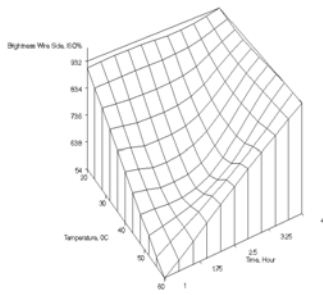

°C  
°C  
( )

( )

...

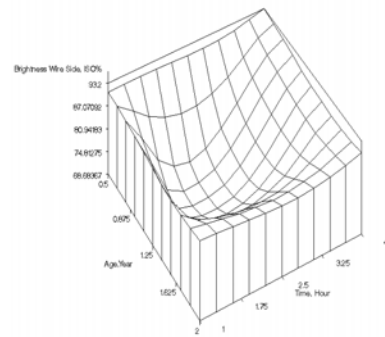
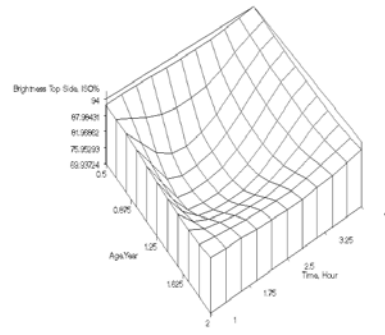
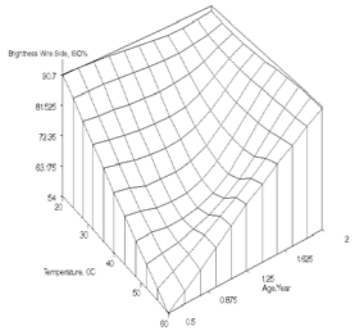

.( )

)

.(

.( )

.( )

.( )

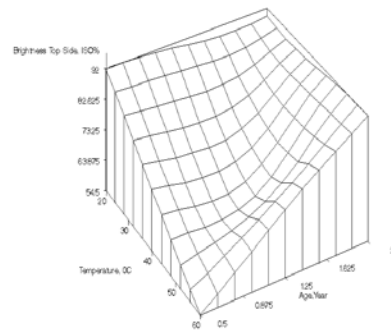



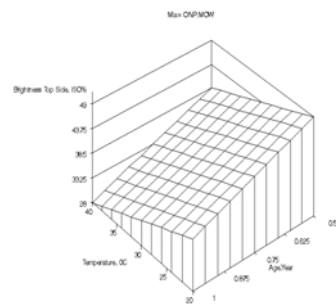
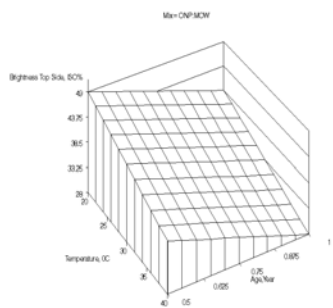
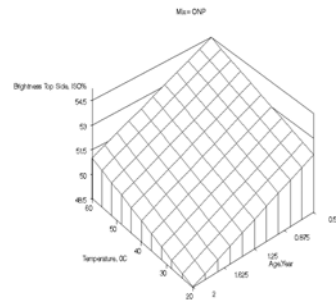
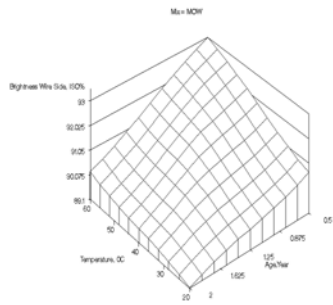
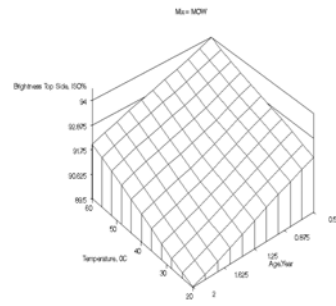
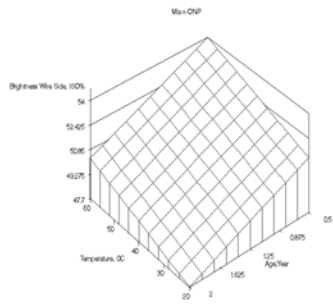

...

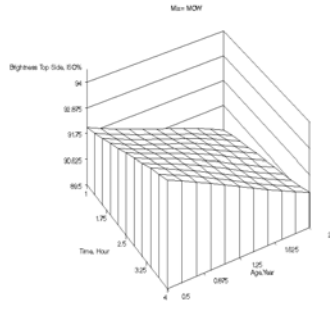

)

.

)

.(

.(

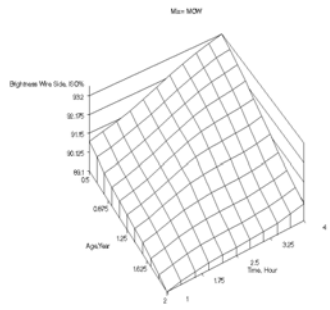

.( )

.( )

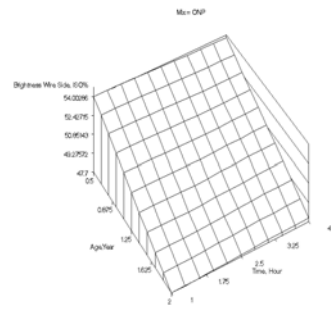
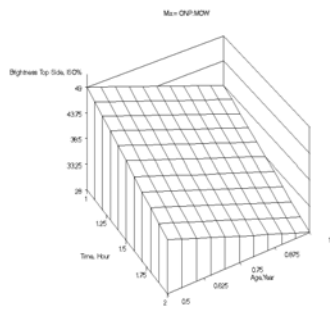
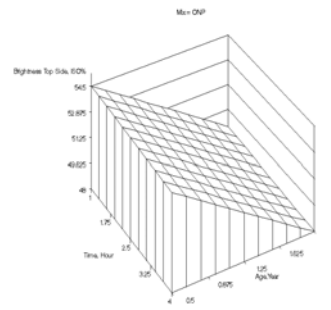

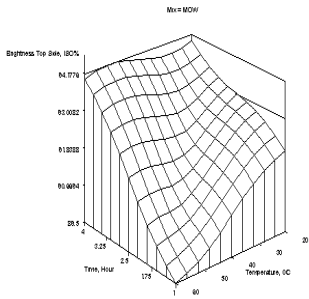
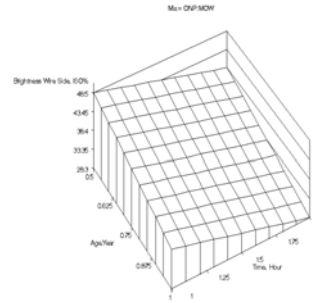
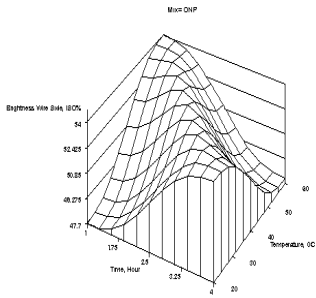

. ( )

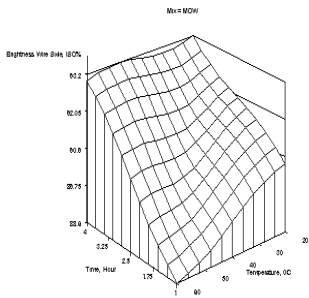

. ( )

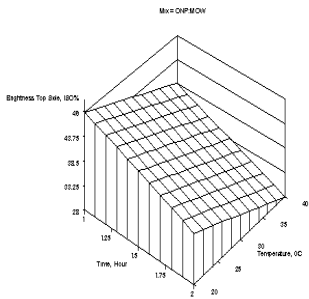

. ( )

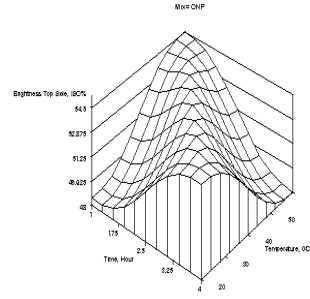

. ( )

...

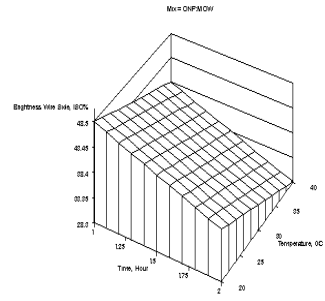

( )  
( )

( )

( )

( )

( )

/

( )  $T_g$

---

$T_g$ =Glass Transition Temperature

- 
- 1-Aldrich, L.C., 1995, Progress in Paper Recycling, pp. 63-67
  - 2-Biermann, C.J., 1996, Handbook of Pulping & Papermaking, Academic Press, London, UK, P263
  - 3-Bocci, A., 1966, U.S. Pat 3253976
  - 4- Goss, R.B, 1971, U.S. Pat 3595741
  - 5- Goss, R.B., 1974, Secondary Fiber-Operating Experience with the Riverside Recovery Process, Paper presented at TAPPI Secondary Fiber Conf. , Boston, MA
  - 6-Gööttsching, L., 1999, Recycled Fiber and Deinking, FAPET Oy, Helsinki, Finland
  - 7-Hamilton, F.R., 1987, Pulping Systems in secondary fibers and non-wood pulping, the joint textbook committee of the paper industry.
  - 8-Hess, H.B., 1935, U.S. Pat 1990376
  - 9- Johnson, A.E., 1967, Paper Trade J.153, no. 40:55
  - 10-Kaul, K.K., 1999, Tappi J., Vol. 82, no.8, pp 115-120
  11. Matussek, H., Salvesen, W., Pearson, J., 1993, International Fact and Price Book, Pulp & Paper International, Miller Freeman Inc., Sanfransisco
  - 12-North American Waste Paper Study , 1991, Vol. 1, Market analysis and forecasting , Special study series No. 17, Resource information Systems Inc.

## A Study of the Possibility of Aquasol Process to Deink ONP and MOW

M.Faezipour<sup>1</sup>   A. Khalafi<sup>2</sup>   S.A.Mirshokraie<sup>3</sup>   A. Lohrasebi<sup>4</sup>   A. Pirjani<sup>5</sup>

### Abstract

A quasol process was used to deink ONP (Old Newsprint) and MOW (Mixed Office Waste). Aqua-solvent and surfactants mixture was applied to dissolve, disperse and remove ink. The efficient dislodge of ink requires optimized conditions of retention time, temperature, solvent type and print age (i.e. aging). Finally, the contaminants, ink particles in particular, were removed along with the solvent by decantation. The results indicated that maximum brightness was achieved using 4 hours of retention time, 60°C temperature, with a print age of 6 months for either of ONP or MOW. Xylene is preferred to dichloromethane; and dichloromethane cannot be applied through conventional devices. A simultaneous increase in retention time and temperature, and a decrease in print age will bring about an increase in brightness. Besides, separate increase of either retention time or temperature increased the brightness phenomenon. The lower the print age, the higher the final brightness achieved throughout the process. In this respect, a substantial part of brightness loss occurred during the first 6 months after printing and later the effect of aging on brightness becoming less significant. The interactive and independent influences of variables have been discussed illustratively and thoroughly.

**Keywords:** Aquasol, Deinking, Print age, Old Newsprint, Mixed Office Waste, Surfactant, Organic solvent, Aging

---

1- Professor, Faculty of Natural Resources, Tehran University ; E-mail:international@ut.ac.ir

2- Graduate of Wood and Paper Sci. and Eng., Faculty of Natural Resources, Tehran University

3- Associate Professor, Payam-e-Nour University

4- Assistant professor, Faculty of Natural Resources, Tehran University

5- Senior Expert, Wood and Paper Sci., and Eng, Production Manager of Latif Paper Co.